

Included

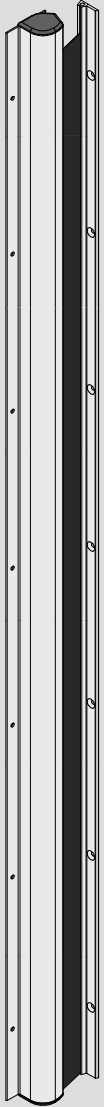

8 X



8 X

Fitting

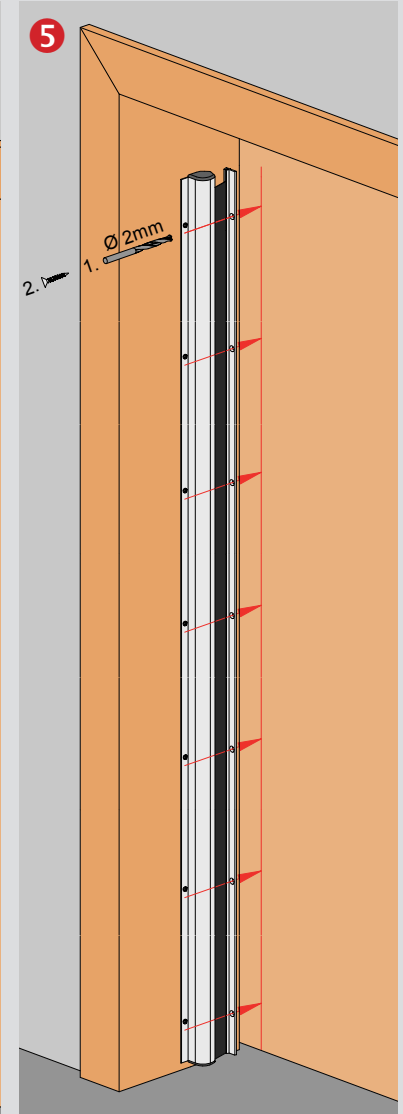
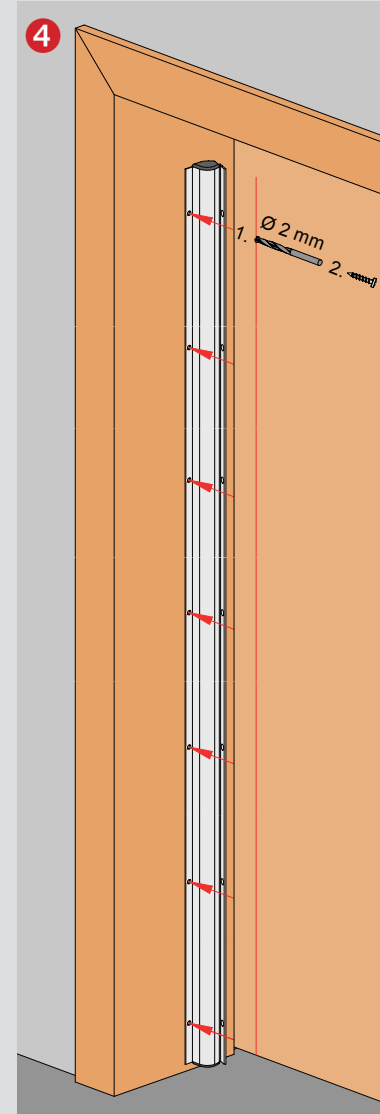
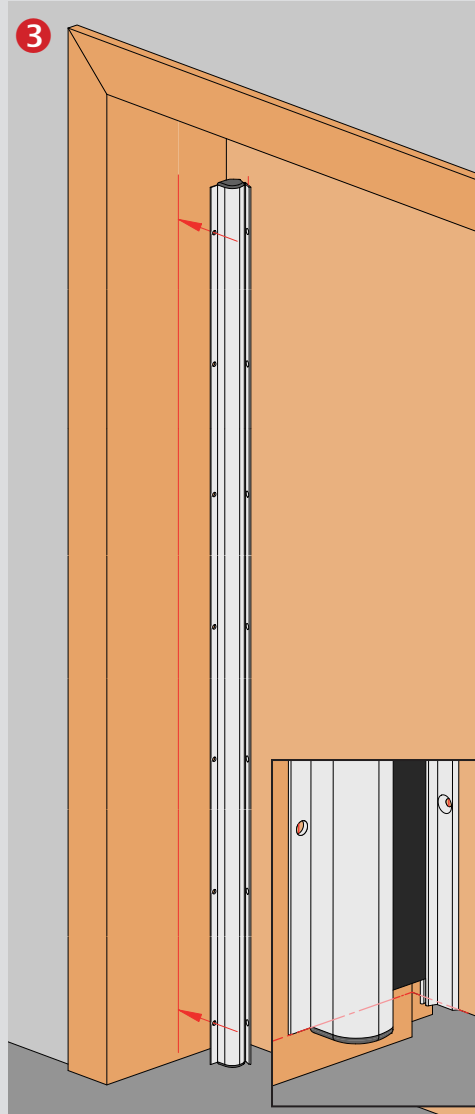
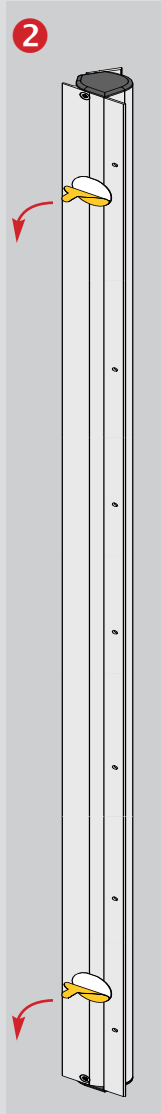
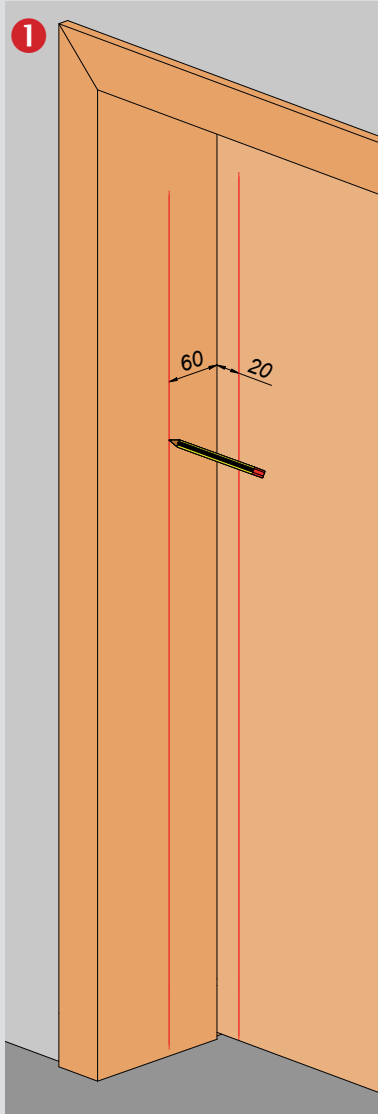

The use of finger protection does not obviate the duty of supervision. Technical specifications are subject to change.

Technical Specifications / Alternative installation applications

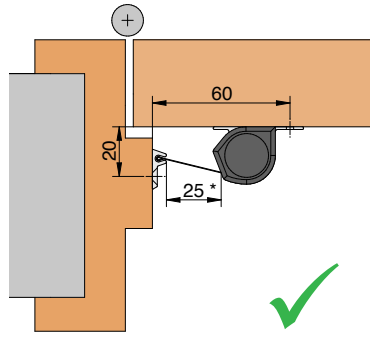
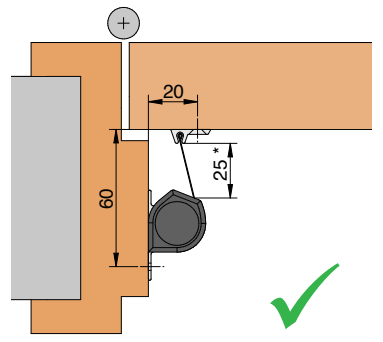

* 25 mm minimum distance required.
According to BS EN 349.

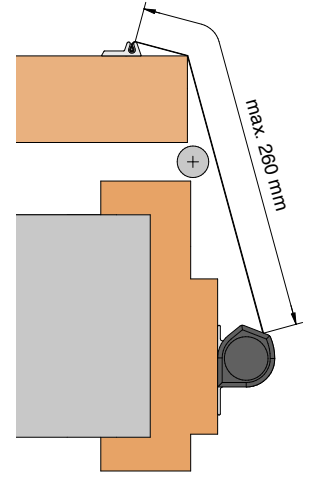

**OPTIONAL: PROTECTION
PROFILES ON THE HINGE SIDE**

FP100

Designed to be fitted with our roller system finger protectors to prevent finger trapping on the hinge pin side of the door. Supplied in predrilled and countersunk lengths of 1.8 metres which can be cut to size and fitted between, above and below hinges. Suitable for standard Ø 12 - 14 mm hinges. Available in various finishes.

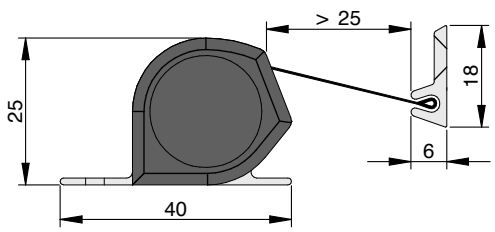
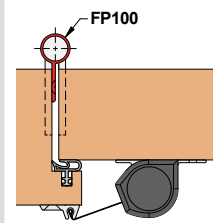

FP200 Dimensions

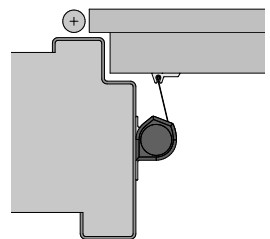
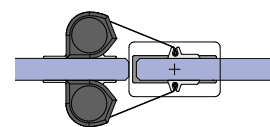
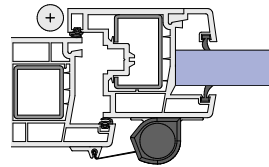
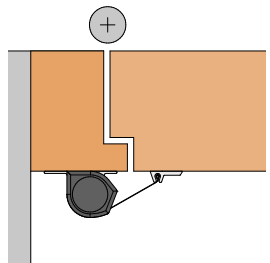

Installations for alternative door style / material.

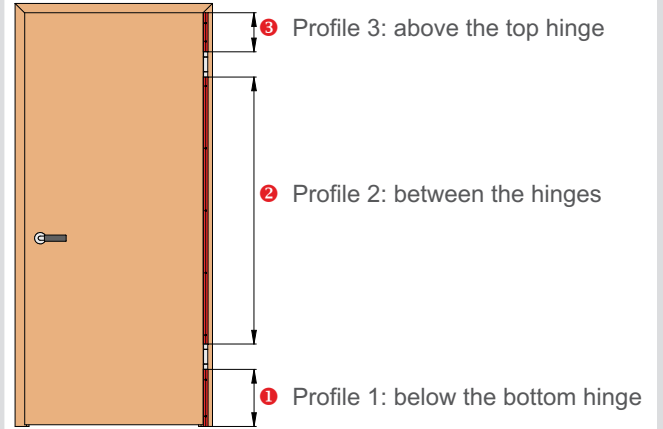

The use of finger protection does not obviate the duty of supervision. Technical specifications are subject to change.